



Technical Data Sheet

User Manual Mx4100, Mx4200 & Mx4400 Fire Alarm Control Panels



The operation and functions described in the manual are available from Software Versions Mx4100-017, Mx4200-017 and Mx4400-017 onwards.

Document Reference	680-015	Rev	5	Author	PS	RFM4100	Page	1
--------------------	---------	-----	---	--------	----	---------	------	---

Contents

1	Introduction	3
2	Controls and Indications	4
2.1	Graphical Display	4
2.2	LED Status Indicators	5
2.3	Control Buttons	5
2.4	Navigation Buttons	5
2.5	Number and Letter Buttons	6
2.6	Buzzer	6
3	Operation	6
3.1	Access Levels	6
3.2	Changing from Access Level 1 to 2	7
3.3	Changing from Access Level 2 to 1	7
3.4	Fire Alarm Condition	8
3.4.1	Detailed Fire Alarm Information	8
3.4.2	Investigation Delays	9
3.5	Fault Condition	10
3.6	Disablement Condition	11
3.6.1	Disabled Inputs	11
3.6.2	Disabled Outputs	12
3.7	Alarm Condition	12
3.8	Menu Functions	13
3.8.1	Using the Buttons to Navigate Menus	14
3.8.1.1	Selecting Menu Options	14
3.8.1.2	Selecting Individual Zone Numbers	14
3.9	Viewing	15
3.9.1	View - Fires	15
3.9.2	View - Faults	15
3.9.3	View - Alarms	15
3.9.4	View - Disabled	15
3.9.5	View - Inputs	16
3.9.6	View - Outputs	16
3.9.7	View - Panel	17
3.9.8	View - Log	18
3.9.9	View - Network	18
3.9.10	View - Logic	18
3.10	Disabling	19
3.10.1	Disable - Zones and Inputs	19
3.10.2	Disable - Outputs	20
3.10.3	Disable - Controls	21
3.10.4	Disable - Delay-Mode	21
3.11	Enabling	22
3.11.1	Enable - Zones and Inputs	22
3.11.2	Enable - Outputs	22
3.11.3	Enable - Delay-Mode	22
3.11.4	Enable - Change-Time	22

3.12	Testing	23
3.12.1	Test - Zones	23
3.12.2	Test - Display	24
3.12.3	Test - Buzzer	24
3.12.4	Test - Printer	24
3.13	Printing	25
3.13.1	Printer Communications Settings	25
3.13.2	Set-up Printer	25
3.13.3	Print - Log	25
3.13.4	Print - Feed Paper	25

Cautions and Warnings



Before commencing with installation or operation of the panel, please read this manual carefully. If you are unclear on any point, **DO NOT** proceed. Contact the manufacturer or supplier for clarification and guidance.



Only Trained service personnel should undertake the Installation, Programming and maintenance of this equipment.



This product has been designed to comply with the requirements of the Low Voltage Safety and the EMC Directives. Failure to follow the installation instructions may compromise its adherence to these standards.



This Fire Alarm Control Panel is compliant with the requirements of EN54 parts 2 and 4 (1998).

Where appropriate, reference is made in this manual to the relevant sections of the EN54 standard for clarification and to ensure that the installation is compliant with the requirements of EN54.

1 Introduction

This manual covers the use and operation of the *Mx-4100*, *Mx-4200* and *Mx-4400* Fire Alarm Control Panels. Refer to the Installation and Commissioning Manual (Document No. 680-014) for details of how to install and program the panel.

The *Mx-4100* is a Single Loop, Analogue Addressable Fire Alarm Control Panel.

The *Mx-4200* is a Multiple Loop, Analogue Addressable Fire Alarm Control Panel with provision for up to two loops.

The *Mx-4400* is a Multiple Loop, Analogue Addressable Fire Alarm Control Panel with provision for up to four loops.

All three panels are designed for use with the Apollo Discovery, Explorer, XP95, Series 90 and Hochiki ESP ranges of fire detection equipment.

Document Reference	680-015	Rev	5	Author	PS	RFM4100	Page	3
--------------------	---------	-----	---	--------	----	---------	------	---

2 Controls and Indications

The *Mx-4100*, *Mx-4200* and *Mx-4400* are provided with indications and control functions as shown in the diagram below and described in the following text:

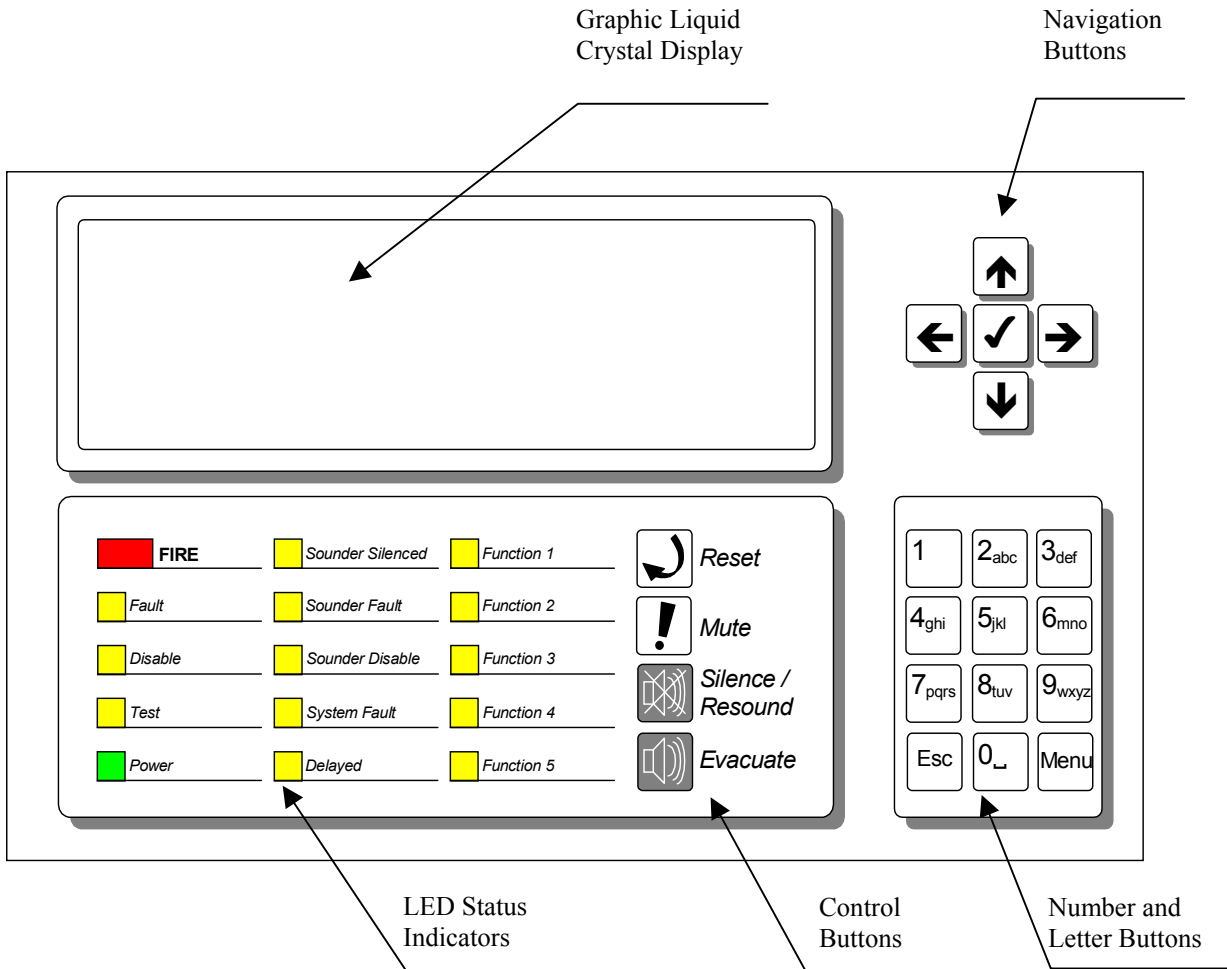

2.1 Graphical Display

The graphical display provides detailed information of the source of fire alarms, faults and warnings. It also shows menus for use when inspecting or programming the operation of the panel.

Under normal conditions the panel display shows the access level, time, date and status :-

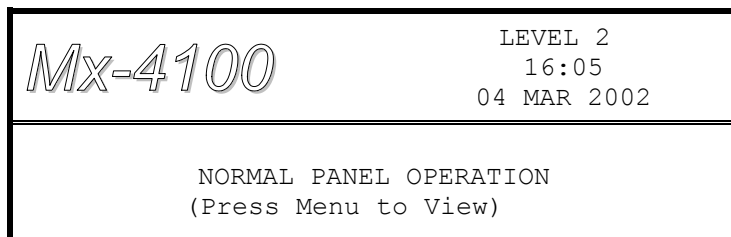





2.2 LED Status Indicators



The LED Status Indications show the basic operational state of the panel and whether the panel is in a fire alarm, fault, disabled or test condition.

Function	Colour	Description
FIRE	Red	Indicates that the system has detected a fire alarm condition
Fault	Yellow	Indicates that the system has detected a fault condition
Disable	Yellow	Indicates that part of the system has been disabled (i.e. isolated)
Test	Yellow	Indicates that part of the system is in a test condition
Power	Green	Indicates the presence of power
Sounder Silenced	Yellow	Indicates that the sounders have been silenced
Sounder Fault	Yellow	Indicates the presence of a fault in one or more sounder wiring circuits
Sounder Disabled	Yellow	Indicates that the sounders have been disabled (i.e. isolated)
System Fault	Yellow	Indicates the presence of a system fault
Delayed	Yellow	Indicates that one or more output circuits are in a delayed operating condition
Function 1	Red	Spare function LED
Function 2	Yellow	Spare function LED
Function 3	Yellow	Spare function LED
Function 4	Yellow	Spare function LED
Function 5	Yellow	Spare function LED

2.3 Control Buttons





	<p>Reset Press to reset the panel from a fire alarm condition.</p>	Only available with Level 2 Access.
	<p>Mute Press to mute the internal buzzer.</p>	Available in both Level 1 and Level 2
	<p>Silence / Resound Press to silence the sounders. Press again to re-activate the sounders.</p>	Only available with Level 2 Access.
	<p>Evacuate Press to initiate a manual evacuation and sound the alarms.</p>	Only available with Level 2 Access.

2.4 Navigation Buttons

	<p>Press to scroll through Menu Options. Press to display more information.</p>
	<p>Press to scroll through menu Options. Press to scroll through lists of zones or devices.</p>
	<p>Press to confirm entry of numeric or letter information entry. Press to confirm selection of a menu option. Press to change some of the configuration options.</p>

Document Reference	680-015	Rev	5	Author	PS	RFM4100	Page	5
--------------------	---------	-----	---	--------	----	---------	------	---

2.5 Number and Letter Buttons

 to 	Used to enter numbers or letters.
	Press to return to a previous menu. Press to exit the menu functions and return to the normal display.
	Press to show or return to Menu Functions.

2.6 Buzzer

The buzzer produces two different sounds to differentiate between fire alarm conditions and fault conditions.

Condition	Operation
Fire Alarm	The buzzer operates with a continuous tone.
Fault	The buzzer operates intermittently .

3 Operation

3.1 Access Levels

The panel operation is protected from inadvertent and erroneous misuse by means of three access levels. These levels are as follows:

- Level 1 Untrained user
- Level 2 Authorised User
- Level 3 Service and Maintenance Engineer

- **A Level 1 Untrained User can view the current operational condition of the system and may MUTE the internal buzzer.**
- **A Level 2 Authorised User can view the operational condition of the system and may MUTE the internal buzzer. In addition, the EVACUATE, SILENCE and RESET buttons are enabled and access to the Level 2 Menu functions is available.**
- **A Level 3 User has access to program and configure the operation of the panel. This is described in detail in the Installation and Commissioning Manual (Part Number 680-014).**

3.2 Changing from Access Level 1 to 2

If the panel has an access keyswitch fitted, use the key in preference to the menu options shown below.

Press the 'MENU' button. The level 1 menu will be displayed as shown below:

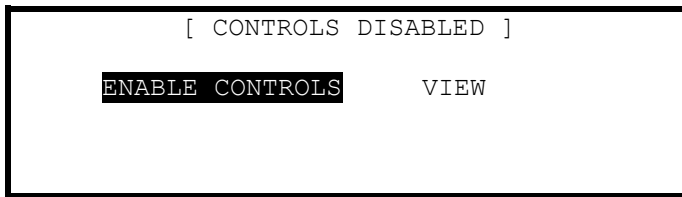

To enable the controls, ensure the "Enable Controls" option is highlighted and then press the ✓ button. The display then requests entry of the Level 2 or 3 password as follows:

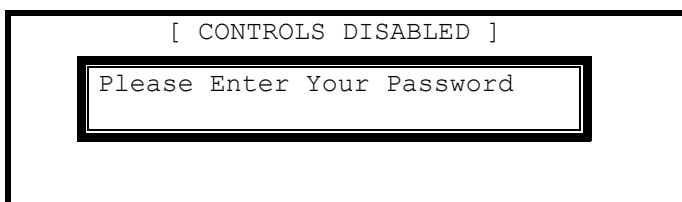

Enter the password using the number buttons and then press the ✓ button. As each number is entered, an asterisk (*) is shown on the display. For example:

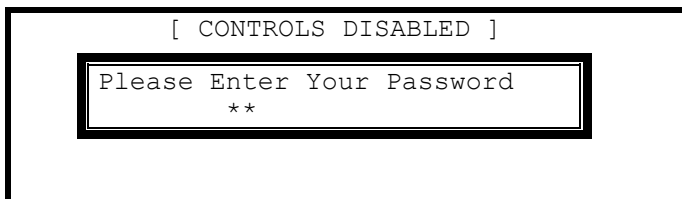

If the password is correct, the Level 2 Menu options will be shown.

If the password is incorrect, the display briefly shows the following message.

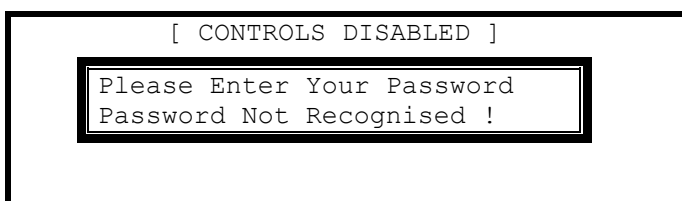

If any of the control buttons (Reset, Silence / Resound or Evacuate) are pressed, the display automatically prompts for the password. Enter the password as above (The function of the control button pressed is not initiated. The button must be pressed again for the panel to action the required function).

3.3 Changing from Access Level 2 to 1

If the panel has an access keyswitch fitted, use the keyswitch.

Alternatively, if passwords are used, call up the "Disablement" menu and select "Disable/Controls" – see section 3.10.3 for details.

Document Reference	680-015	Rev	5	Author	PS	RFM4100	Page	7
--------------------	---------	-----	---	--------	----	---------	------	---

3.4 Fire Alarm Condition

When the system registers a fire alarm condition the Red Fire Indicator illuminates, the internal buzzer sounds (continuously) and the display shows the zone in which the fire originated. The sounders, relays and other outputs will be turned on depending on the programming in the panel. An example of the display is shown below:-

FIRE STARTED IN ZONE 0001	
BASEMENT WEST	< Location Text for First Zone
KITCHEN <CALL POINT >	< Location Text and Type of Device
[1 Zone in Fire][Last Fire in Z0001]	< No. of Zones in Fire & Last Zone
BASEMENT WEST	< Zone Description for Last Zone

The upper part of the display shows the origin of the fire. The lower part of the display shows the number of zones in a fire alarm condition and the last zone to enter the fire alarm condition. This lower fire alarm status display is always present when the panel has registered a fire alarm condition.

If more than one fire alarm condition occurs, the total number of zones in an alarm condition and the last zone in an alarm condition will be updated on the display. If the sounders were silenced, they will sound again whenever the fire spreads to a new zone.

FIRE STARTED IN ZONE 0001. More Alarms>	
BASEMENT WEST	< Location Text for First Zone
KITCHEN <CALL POINT >	< Location Text and Type of Device
[2 Zones in Fire][Last Fire in Z0005]	< No. of Zones in Fire & Last Zone
BASEMENT EAST	< Zone Description for Last Zone

Press the 'MUTE' button to silence the internal buzzer.

When the panel is enabled for Level 2 Access, the following functions are available.

Press the 'SILENCE / RESOUND' button to silence the sounders.



Press the 'SILENCE / RESOUND' button again to re-activate the sounders.

Press the 'RESET' button to clear the alarm condition and restore the panel to normal operation.

Press the 'EVACUATE' button to initiate a manual evacuation and to activate the sounders. The display will show this fire alarm condition. For example:

FIRE STARTED IN ZONE 0100	
MAIN RECEPTION	< Location Text for First Zone
Evacuation Key <SWITCH >	< Confirmation of Evacuation
[1 Zone in Fire][Last Fire in Z0100]	< No. of Zones in Fire & Last Zone
MAIN RECEPTION	< Zone Description for Last Zone

3.4.1 Detailed Fire Alarm Information

Press the   buttons to view a list of all zones in a fire alarm condition.

Zone	FIRE-LOCATION	Scroll ↓	More>	
0001	BASEMENT WEST			< List of Zones in Alarm including
0005	BASEMENT EAST			< Zone No. and location text

If more detail regarding the source of any fires is required, press the **↑↓** buttons to highlight the required zone in alarm and press the **→** button to show further information. For example:

```
[   FIRES IN ZONE 001 ]           More>
LP ADRS  DEVICE LOCATION
1 001.0 KITCHEN
-----
[   2 Zones in Fire][Last Fire in Z0005]
BASEMENT EAST
```

< List of devices within the Zone
< that are in Alarm

< No. of Zones in Fire & Last Zone
< Zone Description for Last Zone

This shows that the device at address 1 on the loop initiated the fire in Zone 1. If there are more Zone 1 devices in alarm, these will be shown in the list. Press the **↑↓** buttons to scroll through the devices. Press the **←** button or the 'Esc' button to return to the previous display. If no button is pressed within 15-seconds, the display automatically reverts to the main display.

3.4.2 Investigation Delays



The Investigation Delay Function can be disabled or enabled as required by EN54: 2. Refer to Section 3.10.4.

If the Investigation Delay Function (Stage 1 / Stage 2 Investigation Delay) is enabled, a fire alarm is registered at the panel but does not immediately activate the sounders. On registering the alarm, the display shows:

```
FIRE STARTED IN ZONE 0001
BASEMENT WEST
KITCHEN <TEMPERATURE>
OUTPUT DELAY 30 s (Press 0 to extend)
-----
[   1 Zone in Fire][Last Fire in Z0001]
BASEMENT WEST
```

< Location Text for First Zone
< Location Text and Type of Device
< Delay Timer (Stage 1)

The Output Delay Timer shows the amount of time left for investigation .

If the alarm is not acknowledged before the Stage 1 timer elapses, the panel will enter a full alarm condition and will activate the sounders.

Pressing the '0' button acknowledges the alarm and extends the time allowed to investigate the source of the fire.

```
FIRE STARTED IN ZONE 0001
BASEMENT WEST
KITCHEN <TEMPERATURE>
OUTPUT DELAY 120 s
-----
[   1 Zone in Fire][Last Fire in Z0001]
BASEMENT WEST
```

< Location Text for First Zone
< Location Text and Type of Device
< Delay Timer (Stage 2)

The cause of the alarm can now be investigated. If the alarm is a false alarm, pressing the 'RESET' button will clear the alarm condition. This must be done before the Stage 2 timer has elapsed or the panel will enter a full alarm condition and will activate the sounders.

Note: The **EVACUATION** button will terminate the investigation delays and activate all programmed sounders.

3.5 Fault Condition

When the system registers a fault condition the Yellow Fault Indicator is illuminated, the internal buzzer sounds intermittently and the display shows the cause of the fault in more detail.

An example of the display is shown below:

ZONE 0001	DEVICE MISSING	
BASEMENT WEST		< Location Text for First Zone
RESTAURANT	(MULTI.SENSOR)	< Location Text and Type of Device
<hr/>		
1 Zone In Fault	More>	< No. of Zones in FAULT

If more than one fault condition occurs, these will be shown on the display. If the internal buzzer was muted, it will sound again when a new fault condition is registered.

When the fault condition is corrected, the panel automatically clears the appropriate fault Status Indicators and Display information.

Press the 'MUTE' button to silence the internal buzzer. The display then shows the current time and date and service centre telephone number along with the indication of the fault.

FOR SERVICE CALL	LEVEL 2	
01234 567890	16:05	< Panel access level
	04 MAR 2002	< Service Call Number
		< and Time / Date
<hr/>		
1 Zone In Fault	More>	< No. of Zones in FAULT

To obtain more detailed information about the faults, press the → button. The display then presents a list of all of the zones in a fault condition with the first fault highlighted. For example:

[2 Zones in Fault]	More>	
ZONE LOCATION		
1 BASEMENT		< Zone #, Location Text and
100 RECEPTION		< number of faults in each zone

Press the ↑↓ buttons to highlight the required fault and then press the → button to show further information. For example:

[Faults in Zone 0001]	More>	
LP ADRS STATE		
1 004.0 DEVICE MISSING		< Address, fault condition

Press the → button to show further information on device location, type analogue/digital values etc.

Press the 'ESC' key to return to the previous display.

If no button is pressed within a minute, the display automatically reverts to the main display.

3.6 Disablement Condition

If any zones, input devices or output devices have been disabled, the DISABLE Indicator is illuminated. In addition, the SOUNDER DISABLE Indicator is illuminated if one or more sounder circuits or devices have been disabled. The display indicates the presence of zone disablement conditions in the lower half of the display as follows:



When the disablement conditions are removed, the appropriate indications are cleared from the display and from the Indicators. When all disablement conditions are removed, the DISABLE Indicator is also turned off.

To obtain more detailed information about the disablement conditions, press the **➔** button. The display will then present the disablement conditions in the following sequence:

- ◆ Zone / Individual Inputs.
- ◆ Outputs

3.6.1 Disabled Inputs

The display presents a list of all of the zones in a disabled condition with the first disablement highlighted. For example:

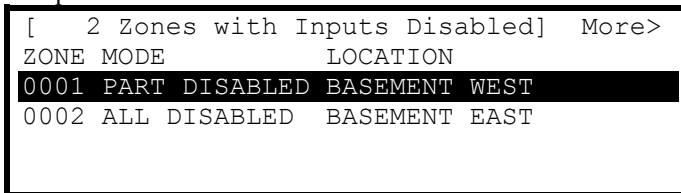

< Zone, disablement condition and
< location text

The display shows the status as ALL DISABLED if every input device within the zone has been disabled and shows the status as PART DISABLED if there is at least one input device within the zone still active.

Press the **↑↓** buttons to highlight the required zone and then press the **➔** button to view the location text assigned to the zone in full. For example:

Press the **➔** button again to view the inputs within the zone and their status. For example:

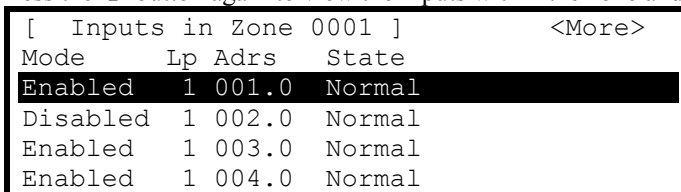

The display shows the current disablement condition (mode) for each input as either enabled or disabled. In addition, the detection loop (LP), address (ADRS) and type of input are shown. Press the **↑↓** buttons to scroll through the inputs.

Press the **➔** button to show further information on device location, type analogue/digital values etc.

Press the 'ESC' key to return.

If there are Outputs also disabled, these will now be shown.

3.6.2 Disabled Outputs

The display presents a list of all of the zones in a disabled condition with the first disablement highlighted. For example:

```
[ 2 Zones with Outputs Disabled] More>
Zone  Mode      Location
0001  DISABLED  BASEMENT WEST
0100  DISABLED  RECEPTION
```

< Zones with location text where
< outputs are disabled

Press the **↑↓** buttons to highlight the required zone and then press the **→** button to view the individual outputs and their disablement condition. For example:

```
[ Outputs in Zone 0100] More>
Mode  Lp Adrs  State
Disabled 0 001.0 Off  Sounder A
Disabled 0 001.1 Off  Sounder B
Enabled  0 011.0 *Off Relay  1
Enabled  0 004.0 Off  Relay  2
```

The above example shows that the panel sounder circuits are disabled.

A * symbol preceding the state (e.g. *Off) indicates the device has been configured as an inverted output (e.g. a fault relay that is designed to de-energise when a fault occurs).

Press the **↑↓** buttons to scroll through the list of individual outputs within the selected zone. Press the **'Esc'** button to return to previous views and the main display.

3.7 Alarm Condition

When the system registers a pre-alarm or plant alarm condition, the internal buzzer sounds intermittently and the display shows the cause of the fault in more detail. An example of the display is shown below:

```
ZONE 0001 PRE-ALARM
BASEMENT WEST
RESTAURANT (MULTI.SENSOR)
1 Zone In Alarm More>
```

< Location Text for First Zone
< Location Text and Type of Device
< No. of Zones in Alarm

To obtain more detailed information about the alarms, press the **→** button. The display then presents a list of all zones in an alarm condition.

3.8 Menu Functions

The following Menu Functions are available at Level 2. The display shows the primary Level 2 Menu as follows:



The following table gives a list of the Level 2 Menu Functions, the sub-functions available within each main function and a brief description for each function.

Main Menu Option	Sub Menus	Comments
VIEW	Fires	View Zones and Inputs that are reporting a fire alarm condition.
	Faults	View Zones and Inputs that are reporting a fault condition.
	Alarms	View Zones and Inputs that are reporting an alarm condition.
	Disabled	View Zones, Inputs and Outputs that are disabled.
	Inputs	View the current state of Inputs.
	Outputs	View the current operational condition of all output circuits/devices.
	Log	View the Event Log.
	Panel	View the operational state, voltage and current loading of the panel input and output circuits.
	Network	View Network diagnostics
DISABLE	Zone / Inputs	Disable a complete zone or an individual input.
	Outputs	Disable sounder outputs or output devices.
	Controls *	Cancel Level 2 access.
	Delay-Mode	Turn off the Stage 1 / Stage 2 Investigation Delay Operation
ENABLE	Zone / Inputs	Enable a complete zone or an individual input.
	Outputs	Enable a complete zone or an individual input.
	Delay-Mode	Turn on the Stage 1 / Stage 2 Investigation Delay Operation
	Change-Time	Allows authorised level 2 users to change time.
TEST	Zones	Configure one or more zones for walk test.
	Display	Test the Graphics Display, Status Indicators and Keyboard.
	Buzzer	Test the Internal Buzzer
	Printer	Test the connection to the Printer
PRINT	Feed Paper	Advance the paper in the printer
	Log	Print the Event Log. (All Events of Fire Only Events Selectable).
	Test	Test the connection to the printer
	Set-up	Configure the printer connection and automatic print options
COMMISSION	---	Enter the Level 3 Commissioning and Panel Programming Functions

*Not required if a keyswitch is fitted for changing access levels.

3.8.1 Using the Buttons to Navigate Menus

Press the 'Menu' button to bring up the display menu .

3.8.1.1 Selecting Menu Options

The Level 2 Menu is shown below:

[Level 2 Menu]		
VIEW	DISABLE	ENABLE
TEST	PRINT	COMMISSION

Press the \leftarrow \uparrow \downarrow \rightarrow buttons to highlight the required menu option and then press the \checkmark button to select it. For example, press the \rightarrow button followed by the \downarrow button to highlight the PRINT option (as shown below) and then press the \checkmark button to select this option.

[Level 2 Menu]		
VIEW	DISABLE	ENABLE
TEST	PRINT	COMMISSION

Press the 'Esc' button from within a menu option to return to the previous menu.
Press the 'Esc' button from the Main Level 2 Menu (shown above) to return to the normal operating display. If a button is not pressed for one minute (15-seconds if the panel is in a fire alarm condition) the display will automatically revert to the normal operating display. Press the 'Menu' button to return directly to the Level 2 Menu display previously shown.

3.8.1.2 Selecting Individual Zone Numbers

When the display is showing a list of Zone Numbers, it is possible to select a specific zone number by using the number keys. For example, if the display is showing a list of zones:

[Inputs]			More>
Zone	Mode	Location	
0001	Enabled	BASEMENT WEST	
0002	Enabled	BASEMENT EAST	
0008	Enabled	GROUND FLOOR	
0009	Enabled	MAIN RECEPTION AREA	

To select a particular Zone, move to the zone number column. The existing zone number will then be highlighted. Enter the required Zone Number using the number buttons, for example 12.

[Inputs]			More>
Zone	Mode	Location	
# 12	Enabled	BASEMENT WEST	
0002	Enabled	BASEMENT EAST	
0008	Enabled	GROUND FLOOR	
0009	Enabled	MAIN RECEPTION AREA	

Finally press the \checkmark button to confirm . The display will then show a new list of Zones with the selected Zone highlighted at the top of the list.

If the number is entered incorrectly, press the 'Esc' button.

3.9 Viewing

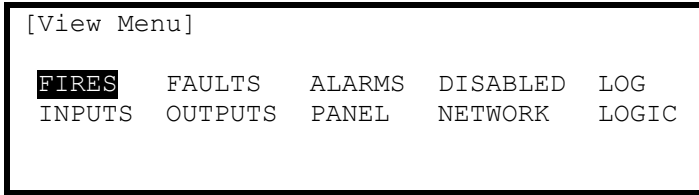

Note that Fires, Faults, Alarms and Disablements are all normally shown without having to select the view menu. If, however, you wish to manually View any of these, they can be selected from this menu as required.

3.9.1 View - Fires

This function shows the Zones and Inputs that are currently in a Fire Alarm condition.

The operation of the panel and the information that can be shown is identical to the views available from the main operating display. Refer to Section 3.3 for further information.

If there are no Zones or Inputs in a Fire Alarm condition, the display automatically reverts to the Main View Menu.

3.9.2 View - Faults

This function shows the Zones, Inputs and Outputs that are currently in a Fault condition.

The operation of the panel and the information that can be shown is identical to the views available from the main operating display. Refer to Section 3.5 for further information.

3.9.3 View - Alarms

This function shows the Zones and Inputs that are currently in an Alarm condition. These may occur if:

- ◆ The Zone or Input is currently in a Fire Test condition and / or
- ◆ Inputs that are configured to generate an alarm or pre-alarm condition when operated are active.

The operation of the panel and the information that can be shown is identical to the views available from the main operating display.

3.9.4 View - Disabled

This function shows only Inputs and Outputs that are currently in a Disabled condition.

The operation of the panel and the information that can be shown is identical to the views available from the main operating display. Refer to Section 3.6 for further information.

If there are both Inputs and Outputs in a Disabled condition, the display presents the inputs first, followed by the outputs.

If there are no Inputs or Outputs in a Disabled condition, the display does not change and continues to show the Main View Menu.

3.9.5 View - Inputs

This function shows the current operational condition for all Zones and Individual Inputs. The display presents a list of all of the zones containing input devices, with the first zone highlighted. For example:

[Inputs]		More>
Zone	Mode	Location
0001	Enabled	BASEMENT WEST
0002	ALL DISABLED	BASEMENT EAST
0008	Enabled	GROUND FLOOR
0009	Enabled	MAIN RECEPTION AREA

Press the **↑↓** buttons to highlight the required zone and then press the **→** button to view the full location text
Press the **→** button again to view the inputs within the zone and their status. For example:

[Inputs in Zone 0008]				<More>
Mode	Lp	Adrs	State	
Enabled	1	001.0	Normal	
Disabled	1	002.0	Normal	
Enabled	1	003.0	Normal	
Enabled	1	004.0	Normal	

The display shows the current disablement condition (mode) for each input as either enabled or disabled. In addition, the detection loop (Lp), address (Adrs) and input state are shown.

Press the **↑↓** buttons to scroll through the inputs.

Press the **→** button to show further information on device location, type analogue/digital values etc.

Press the 'Esc' button to return to previous view.

3.9.6 View - Outputs

This function shows the current operational condition for all Outputs.

[Outputs]			More>
Zone	Mode	Location	
0008	ENABLED	GROUND FLOOR	
0100	ENABLED	MAIN RECEPTION	

Press the **↑↓** buttons to highlight the required zone and then press the **→** button to view the individual outputs.
For example:

[Outputs In Zone 0008]					More>
Mode	Lp	Adrs	State		
Enabled	1	032.0	Off	SOUNDER	
Enabled	1	056.0	Off	SOUNDER	
Enabled	2	011.1	*On	RELAY	
Enabled	3	026.1	Off	RELAY	

A * symbol preceding the state (e.g. *On) indicates the device has been configured as an inverted output (e.g. a fault relay that is designed to de-energise when a fault occurs).

3.9.7 View - Panel

The View Panel Option provides a diagnostic readout of the operational condition and readings for the internal panel electronic circuits. When the option is selected, the display shows a list of the circuits. For example:

[Panel Circuits]			
ITEM	DESCRIPTION	VALUE	STATE
01.0	Sounder A	5.6V	Normal
01.1	Sounder B	5.6V	Normal
02.0	Sounder A Load	0mA	Normal
02.1	Sounder B Load	0mA	Normal

The following table lists the internal panel circuits and indicates the values that can be displayed.

Item	Description	Value Range	Normal	Possible States	
01.0	Sounder A	0V – 14V	5.5V	Normal	Open Circuit, Short Circuit
01.1	Sounder B *				
02.0	Sounder A Load	0mA – 1000mA	**	Normal	Too High
02.1	Sounder B Load *				
03.0	Battery	0V – 30V	27.6V	Normal	Too High, Too Low
04.0	Charger	0V – 30V	28.0V	Normal	Too High, Too Low
05.0	Earth Monitor	0V – 30V	1.3V	Normal	Too High, Too Low
06.0	Aux Supply	0mA – 300mA	**	Normal	Too High
07.0	1 st Loop Load ***	0mA – 500mA	**	Normal	Open Circuit, Too High, Short Circuit
08.0	1 st Loop V.Out ***	24V – 32V	**	Normal	
09.0	1 st Loop V.In ***	24V – 32V	**	Normal	
10.0	Panel Switch Inputs	L/H	L	Normal	Programmable inputs
to				Normal	
10.7		L/H	L	Normal	
11.0	Relay 1	–	–	Normal	
11.1	Relay 2	–	–	Normal	
11.2	Output 1	–	–	Normal	
11.3	Output 2	–	–	Normal	

Note:

* The *MX-4400* also displays Sounders C and D.

** Depends on the panel configuration, installation and current operating condition (i.e. fire alarm).

*** Loop Load, V.Out and V.In displayed for each loop driver (2 on *MX-4200*, 4 on *MX4400*).

Press the **↑↓** buttons to scroll through the panel internal circuits. Press the ‘Esc’ button to return to the main view menu.

3.9.8 View - Log

After selecting to view the log, the display presents a pop-up window to allow selection between a view of all of the event history or a view of only the fire alarms that have occurred.

Press the $\uparrow\downarrow$ buttons to highlight the required menu option and then press the \checkmark button to select it. The display then shows the appropriate list of events.

The display will always show the most recent event to have occurred, e.g.

[View Fire Events]	Entry 0076	< Number of Highlighted Event		
Time/Date	Node Lp:Addr	Zone		
10:54:23	1	1:001.0	001	< Time, Origin and Zone
14/03/02	FIRE ALARM		64	< Date, Event and Analogue Value
BASEMENT				< Zone Text Description
ROOM 10				< Device Location Description

In the above example, the latest fire occurred (Event No. 76) at 10:54 am on March 14, 2002. This fire alarm originated at the device at address 001(Addr) on Loop 1 (Lp) on Panel No. 1 (Panel). The device was in Zone 001. The analogue value registered by the device (64) has also been recorded. The lower two lines show the zone and device location texts descriptions for ease of identification.

Press the $\uparrow\downarrow$ buttons to scroll through the fire alarm events logged in the system. Press the \uparrow button to show more recent events and press the \downarrow button to show earlier events.

To view the details for a specific Log Entry Number, it is possible to select the record by typing in the required number using the number keys. The number entered is echoed at the upper right of the display.

For example:

[View Fire Events]	Entry# 21	< Echo of number entered.
		< These four lines are blank
		< and reverse highlighted
		< until the number entered is
		< confirmed.

Press the \checkmark button to confirm. The display will then display the required record.

Press the 'Esc' button to return to the main view menu.

3.9.9 View - Network

This Option can be used to obtain diagnostic information when a network is used to connect other panels or remote terminals. The access level of all panels on the network can be checked from this display:

[NETWORK - Press 0 to Clear]	More>
Node Status	
1 LOCAL	
2 Level-2	
3 Level-1	
4 -	

Additional network diagnostics are available by selecting the "More>" option.

For further information, refer to the Ad-Net network manual.

Pressing '0' allows the stored network status information to be cleared.

3.9.10 View - Logic

This is a diagnostic aid to assist engineers when first commissioning a complex fire system.

3.10 Disabling

On selecting the Disable Menu, the display shows four possible options. For example:

```
[Disable]
ZONE/INPUTS   OUTPUTS   CONTROLS
DELAY-MODE
```

Press the **←→** buttons to highlight the required menu option and then press the **✓** button to select it.

3.10.1 Disable - Zones and Inputs

This option provides the means to disable a complete zone, disable all input devices except call points or disable individual input devices.

On selecting this option, the display shows a list of the current zones and their current disablement status. For example:

```
[ 0 Zones with Inputs Disabled] More>
Zone   Mode      Location
0001   Enabled   BASEMENT WEST
0002   Enabled   BASEMENT EAST
0008   Enabled   GROUND FLOOR
0009   Enabled   MAIN RECEPTION AREA
```

Press the **↑↓** buttons to scroll through the available zones, or key in a specific zone number.

To disable the entire zone, move over to the Mode column and highlight the existing mode. Press the **✓** button and a pop-up window appears showing the three possible options :-

```
ALL INPUTS
ALL EXCEPT CALL POINTS
SELECTED INPUTS
```

Press the **↑↓** buttons to scroll through and highlight the required option and then press the **✓** button to select it. If ALL INPUTS is chosen, the pop-up window disappears and the State of the Zone is changed to ALL DISABLED.

If the ALL EXCEPT CALL POINTS is chosen, the pop-up window disappears and the State of the Zone is changed to PART DISABLED (if there are actually call points in this zone) or is changed to ALL DISABLED if there are no call points within this zone.

If SELECTED INPUTS is chosen, the pop-up window disappears and a list of the input devices within the selected zone is presented. For example:

```
[ Inputs in Zone 001] More>
Mode   Lp Adrs  State
Enabled 1 001.0 Normal
Disabled 1 002.0 Normal
Enabled  1 003.0 PRE-ALARM
Enabled  1 004.0 Normal
```

Press the **→** button to more information on the inputs, including full device text, type, analogue value etc.

Press the **↑↓** buttons to scroll through and highlight the required input and then press the **✓** button to disable it. Pressing the **✓** button when the input is already disabled will enable the input.

Press the 'Esc' button to return.

3.10.2 Disable - Outputs

The Disable Outputs Option enables the isolation of some or all of the outputs. If disabled, the outputs will not activate in the event of a fire alarm or other programmed event. On selection of the Disable Outputs option, a pop-up window is shown for entry of the Level 2 password. This is to prevent inadvertent disabling of outputs.

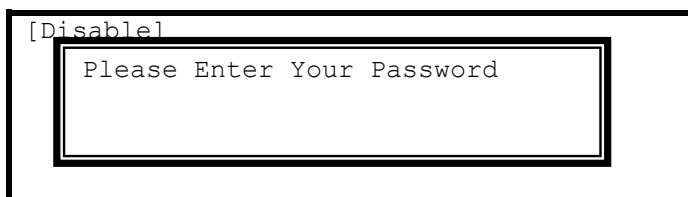

Enter the password as normal. Once a valid password has been entered, a pop-up window is shown on the display to select the type of outputs to disable.



All Sounder Outputs

Press the $\uparrow\downarrow$ buttons to scroll through and highlight the ALL SOUNDER OUTPUTS Option and then press the \checkmark button to disable them. The display automatically reverts to the Main Disable Menu. The 'Sounder Disabled' Indicator will be illuminated.

On networked systems, this is restricted to the sounder outputs connected to this panel.

All Other Outputs

Press the $\uparrow\downarrow$ buttons to scroll through and highlight the ALL OTHER OUTPUTS Option and then press the \checkmark button to disable them. The display automatically reverts to the Main Disable Menu.

On networked systems, this is restricted to the outputs connected to this panel.

Selected Outputs

Press the $\uparrow\downarrow$ buttons to scroll through and highlight the ONLY SELECTED OUTPUTS Option and then press the \checkmark button to select it. The display then shows a list of Zones containing outputs. For example:

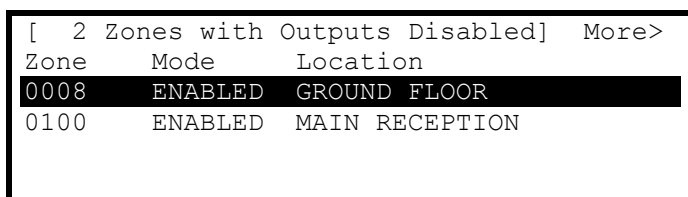

Press the $\uparrow\downarrow$ buttons to scroll through and highlight the required Zone and then press the \rightarrow button to view the outputs within this zone. For example:

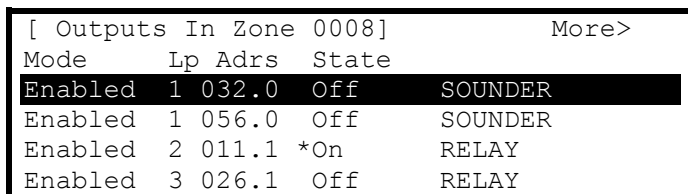

Press the $\uparrow\downarrow$ buttons to scroll through and highlight the required Output and then press the \checkmark button to change the device mode. The device mode will change from Enabled to Disabled and vice-versa.

Press the 'Esc' button to return to the Zone list and to the Main Disable Menu.

3.10.3 Disable - Controls

Disabling Controls will cancel Level 2 access and return the panel to Level 1 operation.

If the panel has an access keyswitch fitted, use the keyswitch in preference to the menu option shown below.

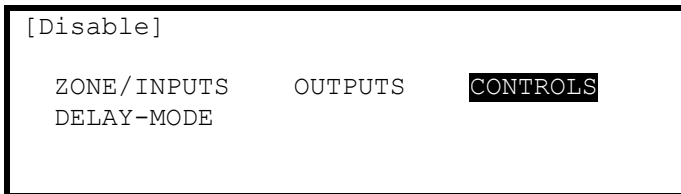

Press the **←→** buttons to highlight the Controls option and then press the **✓** button to select it. The display then prompts for password entry. Enter the password as normal.

When a valid password has been entered, the control button functions and menu functions are disabled and the level 1 menu display will be shown :-



The display will automatically revert to the normal operating display after a few seconds.

3.10.4 Disable - Delay-Mode

This operation will cancel the Investigation Delay mode.

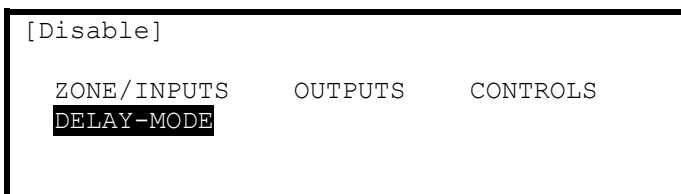

Press the **←→** buttons to highlight the Delay-Mode option and then press the **✓** button to select it.

If the delays are configured in the panel, the display shows the following pop-up window when the Disable Delay-Mode Option is selected. (Note: This delay function can only be configured using the PC Programming Tool).



Highlight the required option using the **↑↓** buttons and then press the **→** button to confirm. The display then reverts to the Disable Options Menu.

Select **NO DELAY** to disable the operation of the Stage 1 / Stage 2 Investigation Function.

Select **USE INVESTIGATION DELAYS** to enable the operation of the Stage 1 / Stage 2 Investigation Function.

If the investigation delays are in operation then the “Delayed” LED Indicator is illuminated. When the

investigation delays are disabled and turned off, the “Delayed” LED Indicator is turned off.

Press **‘Esc’** to cancel and make no change to the current operational setting.

If the delays are not configured in the panel, the display briefly shows “NOT CONFIGURED” before returning to the Disable Menu Options.

3.11 Enabling

On selection of the Enable Menu Option, the display shows the available Enable Functions.

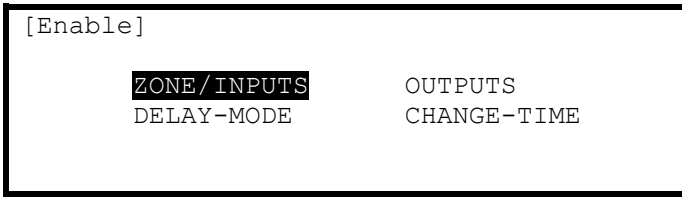

Press the **←→** buttons to highlight the required menu option and then press the **✓** button to select it.

3.11.1 Enable - Zones and Inputs

Selecting this option will show a list of zones containing disabled input devices. Either the complete zone, or individual devices within the zone can then be enabled (Display format is virtually identical to the Disable displays).

3.11.2 Enable - Outputs

When this option is selected, pop-up menu appears asking if you want to enable ALL SOUNDER OUTPUTS, ALL OTHER OUTPUTS or ONLY SELECTED OUTPUTS. If ONLY SELECTED OUTPUTS are selected, the display will list only zones containing outputs that have been disabled. The individual outputs within the zone can then be enabled (Display format is virtually identical to the Disable displays).

3.11.3 Enable - Delay-Mode

This option allows the re-enabling of Investigation Delays.

3.11.4 Enable - Change-Time

Allows the clock time to be changed. Note that a password must be entered before this can be changed. Only level-2 passwords for users 1..5 are accepted.

For example:

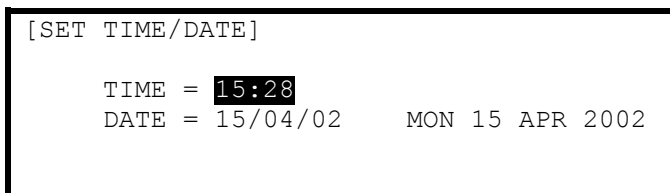

To change the settings, use the **↑↓** buttons to highlight the required option. Directly enter the new time or date using the **number** buttons. As soon as a **number** button is pressed, the display will clear the current setting and show the new value as it is entered. For example:

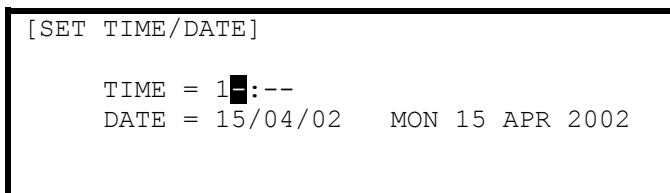

3.12 Testing

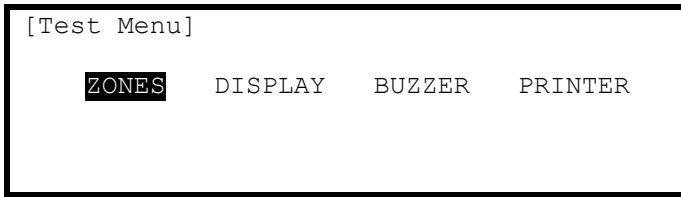

Press the **←→** buttons to highlight the required menu option and then press the **✓** button to select it.

3.12.1 Test - Zones

The Test Zones function provides the means to implement a one-person walk test in order to test specific call points or detectors in one or more zones. When the Test Zones option is selected, a pop-up window is shown on the display to select whether the sounders will activate (for about 10-seconds) when an input device is activated. For example:



Press the **↑↓** buttons to scroll through and highlight the required option and then press the **✓** button to select it. Note that the panel will have been programmed during commissioning to define which of the sounders are activated during a test.

The display then shows a list of the available Zones and their current test status. For example:

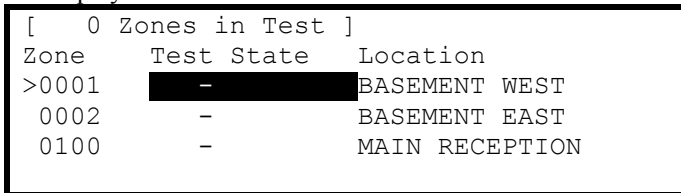

Press the **↑↓** buttons to scroll through and highlight the required zone and then press the **✓** button to change the Test State. For example:

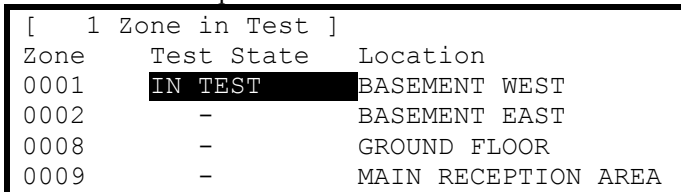

When one or more Zones are placed in a Test State, the Test Indicator will be illuminated. When an input device is activated (i.e. break glass test on a call point or introducing test smoke into a smoke detector), the bells will ring (if selected) and the display will indicate that a zone is registering a test condition by showing an '!' on the display.

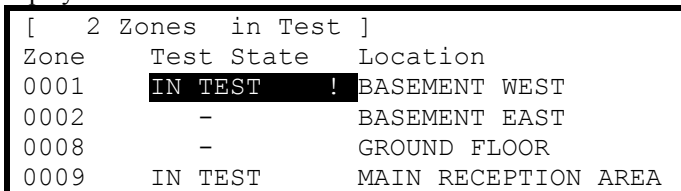

When the activating test key is removed from the call point or the smoke clears from the detector chamber, the panel will automatically reset and clear the test condition.

As an alternative to scrolling, a specific zone number can be entered by using the ← button to move to the zone number column, then typing in the required number, followed by the ✓ button.

If several consecutive zones are to be tested, an alternative to selecting them all individually is to specify a range of zones as follows :-

- moving to the zone number column and highlighting the first zone to test, then
- Pressing the ✓ button – the display will then ask for the last zone to be tested.

Individual zones can then be toggled in or out of test by pressing the ✓ button.

To leave the Zone Test menu, press the ‘Esc’ button. If there are still any zones in a test condition a pop-up window with the following options :-

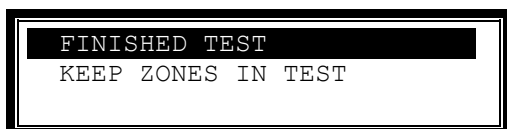

Selecting the FINISHED TEST option will cancel all zone tests. The Test LED will then extinguish.

Alternatively, it is possible to leave the Zone Test Function with one or more Zones still in Test by selecting the KEEP ZONES IN TEST option. This will enable the inspection or use of other menu functions and return the display to the normal operating mode. The Test LED will stay illuminated if this option is selected.

3.12.2 Test - Display

The Test Display option checks the operation of all the Indicators and the Graphic Display. All of the Indicators are turned on and the entire display is shown in reverse .

During this test, it is possible to test the operation of the ←,↑,↓,→,✓ and 0-9 buttons. When a button is pressed, it is indicated on the display. For example:

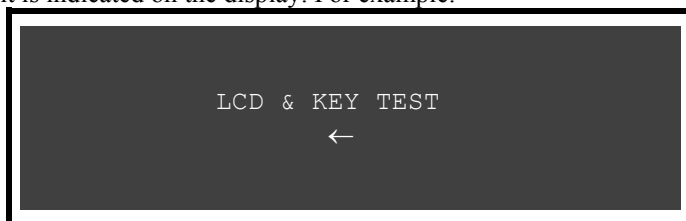

Press the ‘Esc’ button to return to the Test Menu. If no button is pressed for 1-minute, the display will automatically revert to the normal operating display.

3.12.3 Test - Buzzer



When the Test Buzzer option is selected, the internal buzzer will sound for about five seconds.

3.12.4 Test - Printer

To invoke the printing of a test print sequence, highlight the Test Print Option and press the ✓ button to confirm. The panel transmits 16 lines of test characters to the printer. The information sent is echoed on the display.

When the test print is completed, the display automatically reverts to the Test Options Menu.

Press the ‘Esc’ button at any time to cancel the test print.

Document Reference	680-015	Rev	5	Author	PS	RFM4100	Page	24
--------------------	---------	-----	---	--------	----	---------	------	----

3.13 Printing

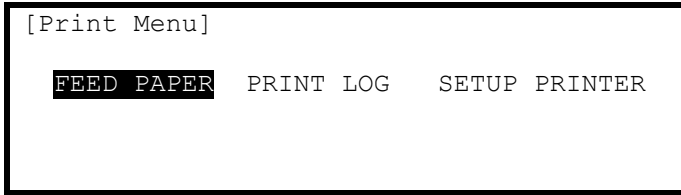

3.13.1 Printer Communications Settings

The information is sent to the printer in a serial form. If an external printer is used, ensure that the communications settings in the printer are set as follows:

Interface Type: RS232
Baud Rate: 9600
Parity: None
Data Bits: 8
Stop Bits: 1

3.13.2 Set-up Printer

To enable or set-up the operating characteristics of the printer, highlight the Set-up Printer Option and press the ✓ button to confirm. The display prompts for entry of the password to guard against inadvertent changes. Enter the password as normal. The display then shows a pop-up window giving programming options as follows:

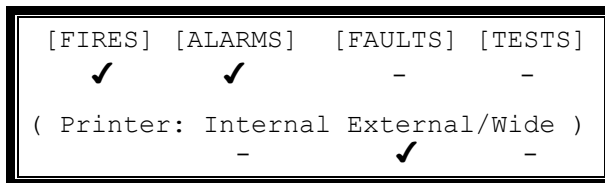

The upper line of options determines whether the panel shall automatically print specific events as they occur.

The lower line of options determines whether a printer is connected and its type.

Use the ←,↑,↓,→ and ✓ buttons to highlight the required option and change its setting. Pressing the ✓ button turns the option on (✓ is shown) or off (- is shown) accordingly.

In the above option, an external printer is selected, with automatic printing of fires and alarms.

Setting the wide option will change the printing from the default 40 characters per line to 80 characters per line.

3.13.3 Print - Log

To print information from the History Log, highlight the Print Log Option and press the ✓ button to confirm. A pop-up window will be shown asking if all events, or just fires should be printed.

Highlight the required option using the ↑↓ buttons and press the ✓ button to confirm.

When the Log Print is completed, the display automatically reverts to the Print Options Menu.

Press the 'Esc' button at any time to cancel the log print.

3.13.4 Print - Feed Paper

Highlight the Feed Paper Option and press the ✓ button to confirm. The display does not change but a command is sent to the printer to advance the paper .